

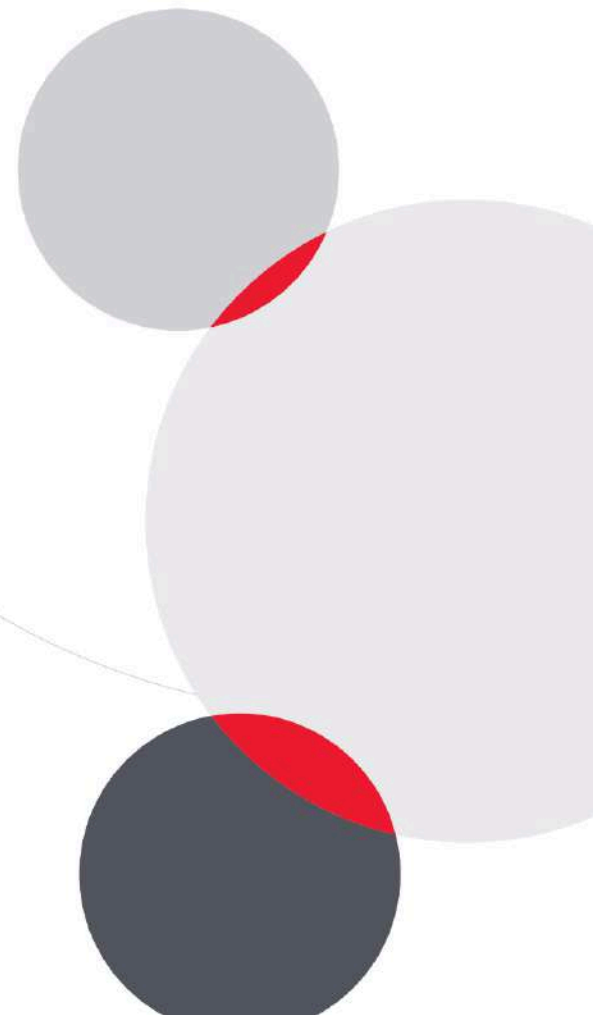

ROOTED RELIEF
A Verdant Approach to Comfort
ASDA26_30914

American Standard



Design Concept Summary

ROOTED RELIEF: A Verdant Approach to Comfort envisions the toilet as a sanctuary where Filipino identity, nature, and modern design converge and rooted in the value of ginhawa, or comfort that is breathable, dignified, and restorative. The design draws from a verdant material palette inspired by the moodboard, where stone-like wall textures recall permanence and heritage, green ceramic tiles evoke foliage and freshness, dark wood flooring adds warmth and depth, beige plaster walls soften the palette, frosted glass diffuses daylight into a gentle glow, patterned tiles introduce cultural rhythm, and a small succulent plant symbolizes resilience and growth. These are balanced by sleek modern fixtures such as a white ceramic sink with a black faucet, a wall-mounted shower system, a foldable shower seat, and a contemporary toilet that ensure clarity, accessibility, and hygiene.

Climate-responsive strategies are integral to the design, with natural ventilation allowing air to circulate freely, daylighting reducing reliance on artificial light, and smooth circulation paths ensuring ease of movement. These elements reflect the Filipino preference for open, breathable spaces that resist confinement, while nature is treated not as a backdrop but as a protagonist. Textures recall flowing water, sunlight, and organic forms, while the verdant palette and organic details ground the design in cultural memory and provide emotional renewal. In urban contexts, the toilet becomes a micro-sanctuary of greenery, offering relief that is not only physical but also emotional and cultural—a reconnection with the rhythms of life.

Accessibility and inclusivity are embedded through foldable seating, intuitive fixtures, and clear circulation, affirming respect for dignity and ensuring usability for all. This weaving of identity into everyday rituals transforms ordinary acts of washing, refreshing, and relieving into cultural reconnections, reminding users of their roots and environment. Ultimately, the project demonstrates how heritage and innovation can merge, how tradition and progress can coexist, and how even the most utilitarian of spaces can carry profound meaning. The toilet is redefined not just as a functional room but as a sanctuary of rooted relief, where comfort is verdant, culture is alive, and design dignifies the rhythms of daily life.

Design: Floor Plan and Elevations

This architectural plan showcases a 3.5m x 2m comfort room designed for both functionality and aesthetic appeal. The layout includes a toilet, sink, and shower area, with distinct flooring zones for wet and dry use. Elevation views highlight modern fixtures, wood and tile finishes, and thoughtful storage solutions. Natural elements like plants and textured surfaces evoke warmth and comfort, aligning with a nature-inspired, culturally rooted design approach.

**Total Bathroom Area
in sqm (including wall
& columns)**

7 sqm

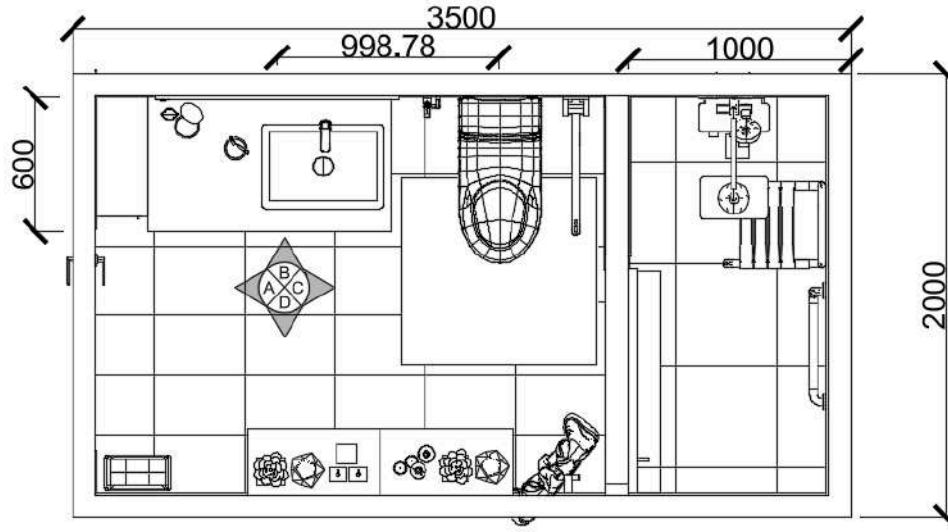

FLOOR PLAN

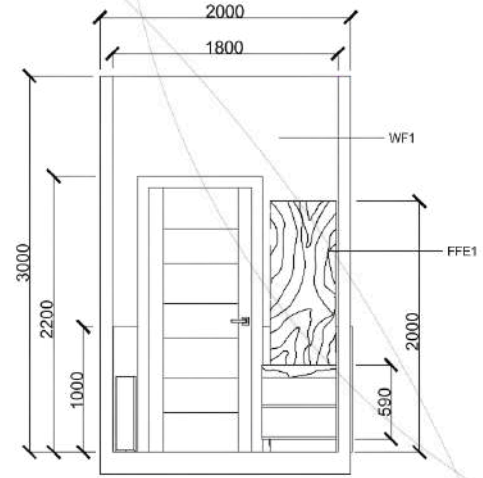

ELEVATION A

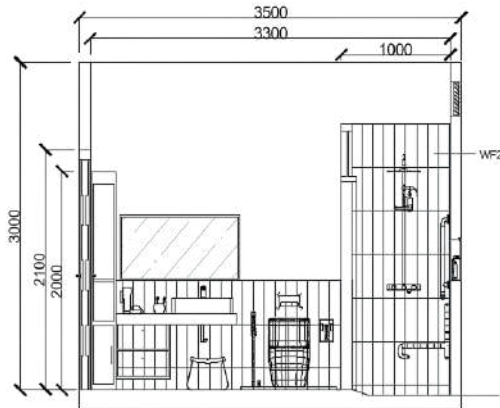

ELEVATION B

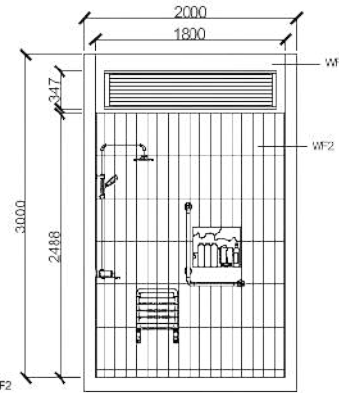

ELEVATION C

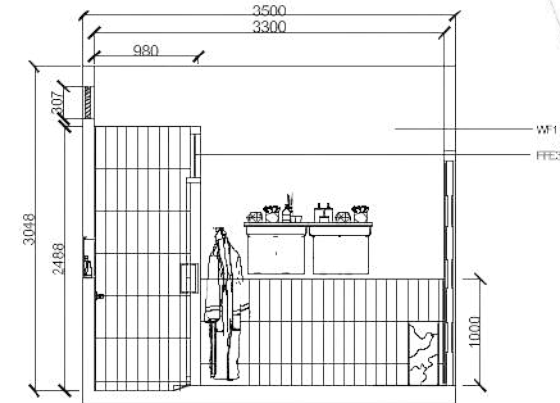

ELEVATION D

Design Visuals: Overview

The comfort room is a well-planned, modern space that integrates accessibility, functionality, and aesthetic warmth. Spanning 3450 mm in width and 2000 mm in depth, its layout includes a vessel sink on a stone or wooden countertop, a toilet with support features, and a shower area enclosed by frosted glass panels. Vertical green tiles line the lower walls, contrasting with white-painted surfaces above, while dark wood flooring adds depth and texture. Storage is thoughtfully incorporated through shelves and hooks for towels and robes. The overall design balances safety and style, creating a user-friendly environment that feels both fresh and grounded.

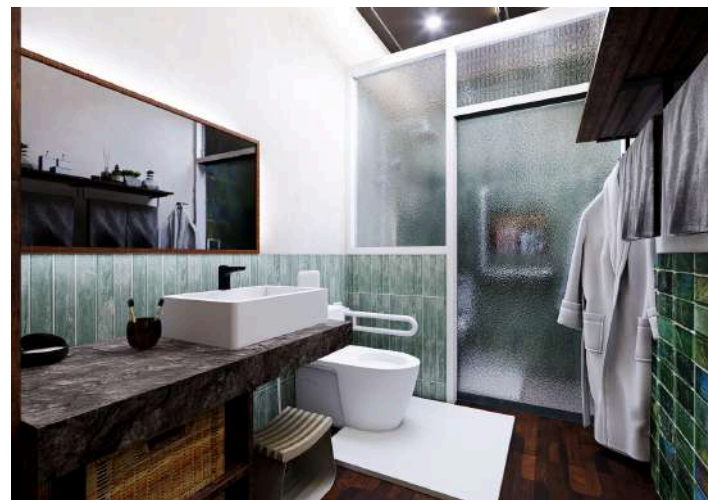
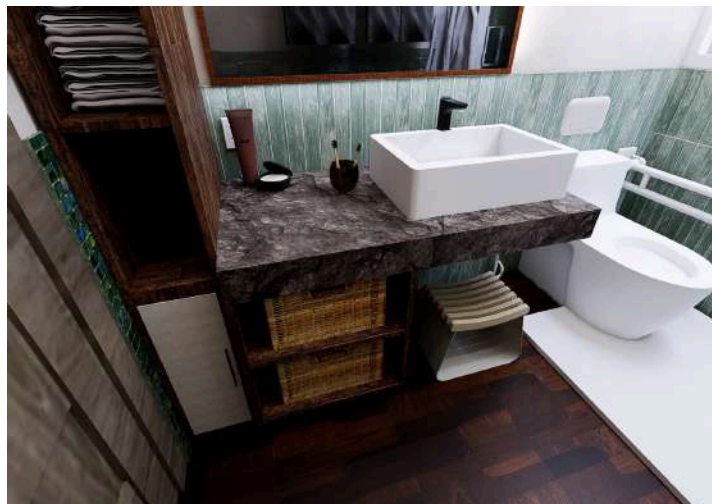
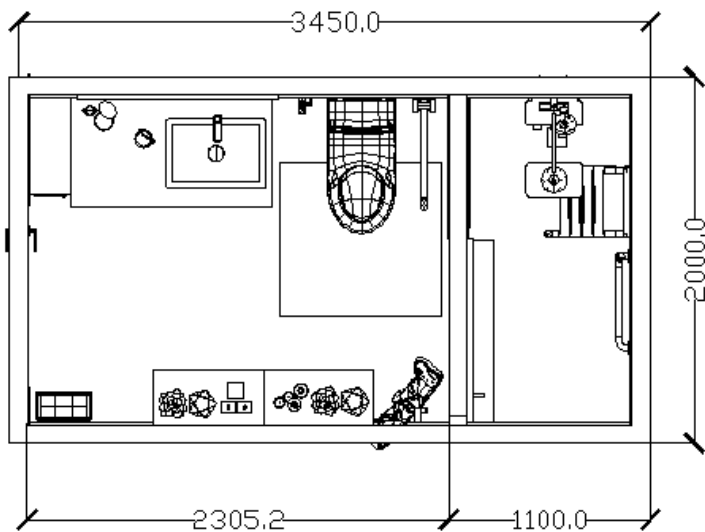

Design Visuals: Full Bathroom

The comfort room presents a cohesive blend of accessibility, warmth, and modern design. It features a white vessel sink on a rustic wooden countertop, paired with a large framed mirror that enhances depth and light. Vertical green tiles line the lower walls, adding freshness and contrast against the white-painted upper surfaces. The toilet area includes a side-mounted grab bar for safety, while the shower zone is enclosed with frosted glass and equipped with a rainfall and handheld showerhead, a wall-mounted seat, and multiple grab bars for support. Wooden flooring and thoughtful storage elements—like recessed shelves and hanging racks—tie the space together, creating a functional, user-friendly environment that prioritizes comfort, safety, and style.



Design Visuals: Shower Area

The shower area of the comfort room is thoughtfully designed for both accessibility and comfort. It features green-tiled walls and is equipped with a rainfall showerhead, a handheld showerhead, and a wall-mounted shower seat to accommodate users with varying mobility needs. Multiple white grab bars are strategically placed for safety and support, while a recessed shelf offers convenient storage for personal care products. Frosted glass panels enclose the space, providing privacy without compromising light and openness. The overall layout reflects a balance of functionality, safety, and modern aesthetics.



Design Visuals: Toilet Area

The toilet area of the comfort room is designed with accessibility and comfort in mind. It features a side-mounted grab bar for support, ensuring safer use for individuals with mobility needs. The surrounding walls are clad in vertical green tiles, adding a fresh, calming aesthetic that complements the dark wood flooring. Adjacent to the toilet is a textured glass partition that subtly separates the space while maintaining openness. The layout balances functionality with thoughtful design, making the area both user-friendly and visually cohesive.



Design Visuals: Basin Area

The basin area of the comfort room showcases a clean and modern aesthetic, anchored by a rectangular white vessel sink set atop a dark marble countertop. Beneath the counter, a wooden vanity adds warmth and texture, complementing the vertical green tiles that line the lower portion of the wall. A large wooden-framed mirror above the sink enhances the sense of space and reflects the natural tones of the materials. The overall composition balances sleek fixtures with earthy finishes, creating a functional yet inviting focal point within the bathroom.



Design Visuals: Optional Images/ Information

The bathroom design features a thoughtful blend of functionality and warmth through its use of niche shelving, hanging storage, and a framed mirror. A recessed niche shelf is built into the green-tiled wall, offering streamlined storage for personal care items while maintaining a clean, uncluttered look. Above the sink, a wooden hanging shelf adds a natural touch, hosting small potted plants and essentials like a soap dispenser—an efficient use of vertical space that enhances the room's cozy ambiance. Complementing these elements is a large rectangular mirror with a wooden frame, which not only expands the visual space but also reflects the earthy tones of the shelf and tiles, anchoring the vanity area with both practicality and aesthetic balance.







Specifications: Colors, Materials and Finishes



This collage presents a curated selection of bathroom fixtures and finishes for a modern, accessible comfort room. It features a wall-mounted shower system, foldable shower seat, sleek white sink with black faucet, and a minimalist toilet. Surrounding textures include dark stone, beige marble, green ceramic tiles, frosted glass, and rich wood parquet—evoking a balance of nature, warmth, and durability. A small succulent adds a touch of organic calm, tying the palette to a nature-inspired design ethos.







Specifications: Colors, Materials and Finishes

This curated material palette blends durability, cultural texture, and climate responsiveness for a comfort room rooted in Filipino identity. Wall finishes include mildew-resistant cream beige enamel paint (WF1) and textured green porcelain tiles (WF2), offering both hygiene and visual freshness. Flooring materials range from lacquered marine plywood sealed with epoxy (FFE1) for dry zones, to honed slate stone tiles (FFE2) and slip-resistant granite (FF2) for wet areas. Frosted tempered glass (FFE3) ensures high privacy while allowing light diffusion. Marquet wood flooring (FF1) adds warmth and elegance through engineered hardwood with a protective polyurethane seal. Together, these materials support a verdant, breathable, and culturally grounded design.





	Material	Material Image	Specifications
WF 1	Cream Beige Paint		Satin Finish Enamel Mildew-resistant additives
WF 2	Green Tiles		Porcelain tile textured Wall
FF E1	Marine Plywood		Marine Plywood for flooring Lacquered and stained Sealed with epoxy resin
FF E2	Stone		honed slate stone tiles 300x300mm, 12mm thk Wet slip resistance Sealed with a penetrating sealer

	Material	Material Image	Specifications
FFE 3	Forsted Glass		Tempered Glass Sandblasted Provacy level - High
FF1	Marquet Wood Flooring		Engineered hardwood with marquetry veneer polyurethane sealant Dry zones flooring
FF2	Granite Tile Flooring		natural Granite stone Textured for slip-resistance shower flooring

American Standard Products Specified

	Product Name	Product Image	Reason for Selection
1	Acacia SupaSleek One-Piece Toilet (S-Trap 305mm) CL20075-6DACTCBT (Toilet)		The Acacia line was chosen for its natural aesthetic, streamlined one-piece design, and clean form that enhances spatial purity.
2	EasySET Exposed Auto Temperature Shower_Brushed Hard Graphite FFAS4956-601AL0BF0 (Bath & Shower)		The smart digital shower was selected for its precise temperature and flow control, ensuring comfort and efficiency.
3	Acacia SupaSleek Vessel 550mm CCASF412-1000410F0 (Basin)		This piece unites artistry and function, with ultra-thin edges evoking stone shaped by flowing water.
4	EasyFLO Basin Mono (Matt Black) FFAS7823-109440BF0 (Basin faucet)		This faucet conserves water while offering a calming, stream-like flow.

	Product Name	Product Image	Reason for Selection
5	DuoSTiX™ Hygiene Spray (Chrome/Matte Black) FFASTS28-000440BT0 (Hygiene Spray)		This fixture combines compact, user-friendly design with dual-function efficiency, minimizing water use while adding modern practicality.
6	90 Degree Angle Safety Grab Bar FFAS9401-000040BC0		The 90° Angle Safety Grab Bar enhances bathroom safety and accessibility with dual vertical and horizontal support, ensuring stability for standing, sitting, and transferring.
7	Acacia E Tissue Holder_Matt Black FFAS1387-908440BF0 (Accessories)		The Concept Square Single Tissue Holder in matte black combines simplicity with bold modern presence.
8	Concept Square Robe Hook_Brushed Hard Graphite FFAS0481-908AL0BF0 (Accessories)		The Concept Square Robe Hook in brushed hard graphite combines style and practicality.

	Product Name	Product Image	Reason for Selection
9	Concept Square Towel Shelf_Brushed Hard Graphite FFAS0495-908AL0BF0 (Towel shelf)		The Concept Square Towel Shelf in brushed hard graphite combines functionality with style, offering organized storage in a clean, modern square form.
10	Chrome Concept Pillow button CCASP406-0005060C0		The Chrome Concept Pillow Button combines ergonomic functionality with refined design, offering smooth, responsive operation for user comfort.
11	Shower Nylon chair FFAS9407-000040BC0		The Shower Nylon Chair emphasizes safety, comfort, and accessibility with its durable, water-resistant nylon and corrosion-resistant frame.
12	L Nylon grab bar(Right) FFAS9405-000040BC0		The L Nylon Grab Bar (Right) features an ergonomic L-shaped design offering vertical and horizontal grip for stability during standing, sitting, or transfers.

Appendix

Design Story – Limit to 150 words per answer.

- What is the inspiration for your design?

My inspiration for my design is nature. Incorporating the colors and materials found outside makes the space much more lively and gives the space more color to its basic neutrality.

- How does the design fulfill the need of the target users?

The design fulfills the need of the target users by integrating water-efficient fixtures and ergonomics layouts for accessibility. The aesthetic blends Filipino identity with modern design, creating a toilet/comfort room that is not only functional but also user-centered.

- How does the design fulfill the design challenge?

The design fulfills the challenge of working within a 7sqm space and using a specific brand of bathroom products (American Standard). The strategic zoning ensures comfort and hygiene despite the limited area to work on, while the brand's products are integrated to maintain consistency in style and performance.

- How does the choice of products contribute to the purpose of the design?

The choice of the products contributed to the purpose of the design to be sustainable. All the products chosen for this project were all sustainable and energy/resource-saving products.

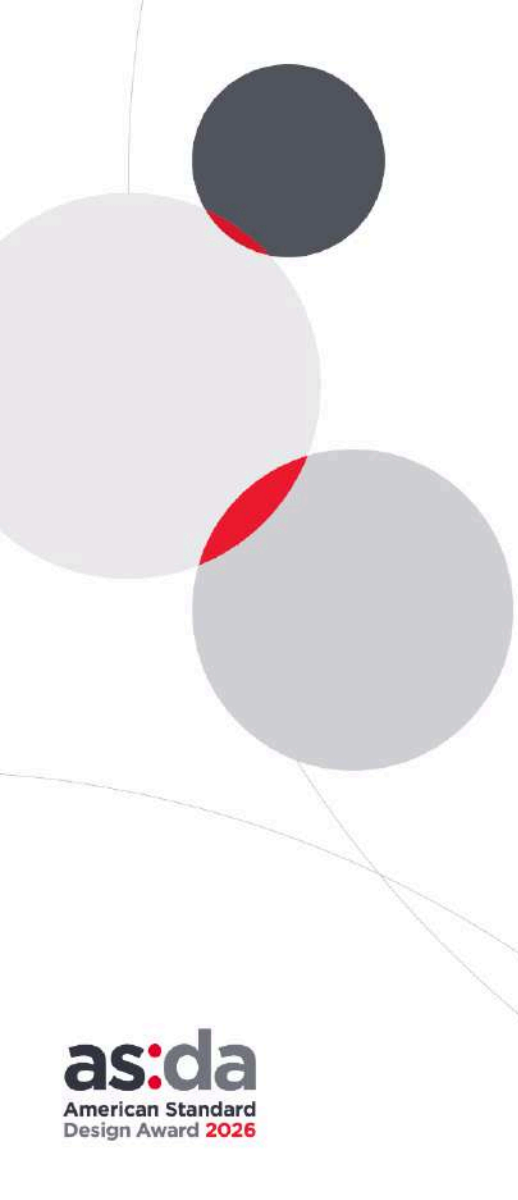

-
-
-
-
-
-
-
-

Check if completed:
Participant ID is indicated on Slide 1 – only <u>one</u> participant per entry (no group work) and <u>one</u> submission per login account
Entry is an original design by the participant
Entry is complete in the required template
Size of bathroom in design entry is within the allowable range
Participant is not a relative to LIXIL employees and/or Closely Related Persons of LIXIL employees and/or of the judges
Participant resides within the participating countries on a full-time basis and the participant is physically attending their studies (in any manner) at a university or educational institution situated outside of the specified countries. <i>Participating countries are ANZ (being Australia and New Zealand), Indochina (being Cambodia, Laos, and Myanmar), Indonesia, Philippines, Thailand, and Vietnam.</i>
Only American Standard products are used in renderings